

# THE PANEL 2

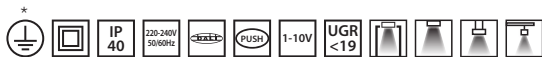

\* Solo versione DALI/PUSH/1-10V

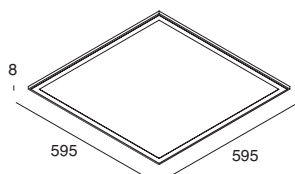

**THE PANEL 2**  
**600x600**

POWER	FLUX	3000K	FLUX	4000K
35W	3343 lm	<input type="checkbox"/> <b>102001.01</b>	3447 lm	<input type="checkbox"/> <b>102002.01</b>

**DALI-PUSH-1-10V**

POWER	FLUX	3000K	FLUX	4000K
35W	3343 lm	<input type="checkbox"/> <b>102035.01</b>	3447 lm	<input type="checkbox"/> <b>102036.01</b>

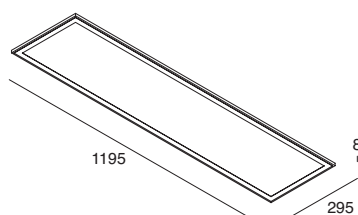

**THE PANEL 2**  
**1200x300**

POWER	FLUX	3000K	FLUX	4000K
35W	3343 lm	<input type="checkbox"/> <b>102007.01</b>	3447 lm	<input type="checkbox"/> <b>102008.01</b>

**DALI-PUSH-1-10V**

POWER	FLUX	3000K	FLUX	4000K
35W	3343 lm	<input type="checkbox"/> <b>102037.01</b>	3447 lm	<input type="checkbox"/> <b>102038.01</b>

# THE PANEL 2 MICROPRISMATICO



\* Solo versione DALI/PUSH/1-10V

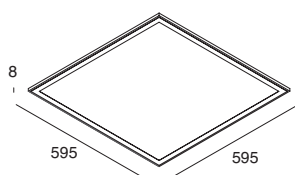

**THE PANEL 2**  
**MICROPRISMATICO**  
**600x600**

POWER	FLUX	3000K	FLUX	4000K
32W	3386 lm	<input type="checkbox"/> <b>102062.01</b>	3490 lm	<input type="checkbox"/> <b>102063.01</b>

**DALI-PUSH-1-10V**

POWER	FLUX	3000K	FLUX	4000K
32W	3386 lm	<input type="checkbox"/> <b>102064.01</b>	3490 lm	<input type="checkbox"/> <b>102065.01</b>

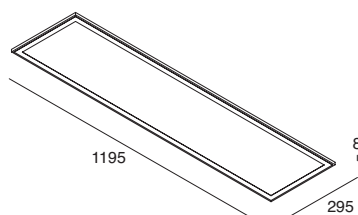

**THE PANEL 2**  
**MICROPRISMATICO**  
**1200x300**

POWER	FLUX	3000K	FLUX	4000K
32W	3386 lm	<input type="checkbox"/> <b>102066.01</b>	3490 lm	<input type="checkbox"/> <b>102067.01</b>

**DALI-PUSH-1-10V**

POWER	FLUX	3000K	FLUX	4000K
32W	3386 lm	<input type="checkbox"/> <b>102068.01</b>	3490 lm	<input type="checkbox"/> <b>102069.01</b>

Pannello LED con cornice in lega di alluminio verniciata a polvere di colore bianco, diffusore opale in PMMA resistente ai raggi UV.

UGR<19 4H-8H, S=0,25, indice di riflessione 70-50-20.

Versione 600x600 mm installabile ad incasso su controsoffitto a pannelli 600x600 mm con struttura a vista senza accessori, per le altre installazioni prevedere gli opportuni accessori da ordinare a parte. Alimentatore elettronico incluso.

LED panel with frame made of white powder coated aluminium alloy, opal diffuser in PMMA, UV resistant. UGR<19 4H-8H, S=0,25, reflexion index 70-50-20.

No accessories needed for installation on 600x600 mm visible-structure ceiling, accessories for other installations to be ordered separately. Integrated electronic driver.

Pannello LED con cornice in lega di alluminio verniciata a polvere di colore bianco, diffusore microprismatico UGR<19 in PMMA resistente ai raggi UV.

Versione 600x600 mm installabile ad incasso su controsoffitto a pannelli 600x600 mm con struttura a vista senza accessori, per le altre installazioni prevedere gli opportuni accessori da ordinare a parte. Alimentatore elettronico incluso.

LED panel with frame made of white powder coated aluminium alloy, micro-prismatic diffuser UGR<19 in PMMA, UV resistant.

No accessories needed for installation on 600x600 mm visible-structure ceiling, accessories for other installations to be ordered separately. Integrated electronic driver.

## THE PANEL 2

### ACCESSORI PER INSTALLAZIONE AD INCASSO ACCESSORIES FOR RECESSED MOUNTED

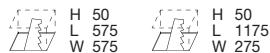
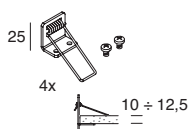

#### KIT MOLLE PER INSTALLAZIONE AD INCASSO

Per versioni 600x600 e 1200x300, per installazione in battuta in cartongesso di spessore 10-12,5 mm.

#### SPRINGS KIT FOR RECESSED INSTALLATION

For 600x600 and 1200x300 versions, for installation by frame contrasting in plasterboard of thickness 10-12,5 mm.

CODE

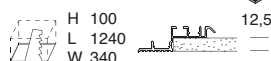
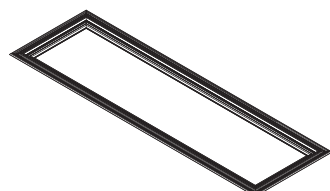
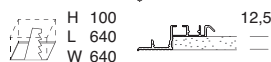
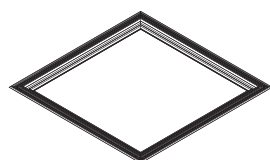
**16215.99**

#### KIT PER INSTALLAZIONE AD INCASSO A RASAMENTO

Profilo da rasare su cartongesso di spessore 12,5 mm.  
Il pannello si installa in appoggio

#### KIT FOR LEVELLED RECESSED INSTALLATION

Profile to be levelled on 12,5 mm thick plasterboard.

CODE

VERSION

**102028.99**

600x600

**102029.99**

1200x300

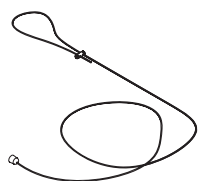

#### KIT ANTICADUTA

Cavo in acciaio da fissare a soffitto o strutture tramite morsetto in ottone nichelato e aggancio a vite sul pannello.

#### ANTI FALL-OUT KIT

Steel cable to be fixed to the ceiling or structures using a nickel-plated brass clamp and screwed on the panel.

CODE

L (mm)

**102031.99**

3000

Per accessori di installazione su controsoffitti a struttura nascosta, contattare l'ufficio tecnico Novalux.  
For installation accessories on concealed grid ceilings, please contact Novalux technical office.

## THE PANEL 2

### ACCESSORI PER INSTALLAZIONE A PLAFONE ACCESSORIES FOR CEILING MOUNTED

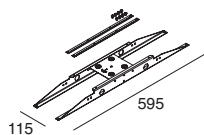

**KIT PER INSTALLAZIONE A PLAFONE**  
Per versioni 600x600 e 1200x300, non installabile a parete o in fila continua. Distanza tra prodotto e soffitto 40 mm.

CODE

**16213.99**

**KIT FOR CEILING MOUNTING**  
For 600x600 and 1200x300 versions, not suitable for wall surface or continuous line installation. Distance between the fixture and the ceiling 40 mm.

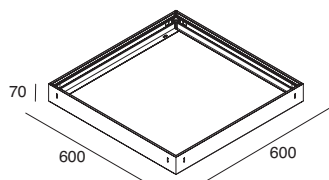

**BOX PER INSTALLAZIONE A PLAFONE**  
Kit da assemblare, non installabile a parete. Idoneo per l'alloggiamento del kit di emergenza (102025.99/102026.99).

CODE

**102033.01**

VERSION

600x600

**102034.01**

1200x300

**KIT FOR CEILING MOUNTING**  
To be assembled, not suitable for wall surface mounting. Suitable for emergency kit (102025.99/102026.99).

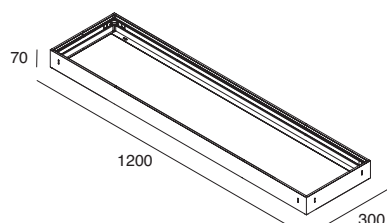

**BOX DECORATIVO PER INSTALLAZIONE A PLAFONE**  
Superficie esterna verniciata bianca o nera, interno bianco. Non installabile a parete. Non idoneo per l'alloggiamento del kit di emergenza.

CODE

**102051.01**

VERSION

.02 600x600

**102052.01**

.02 1200x300

**DECORATIVE BOX FOR CEILING MOUNTING**  
External surface white or black painted, internal white. Not suitable for wall surface mounting. Not suitable for emergency kit.

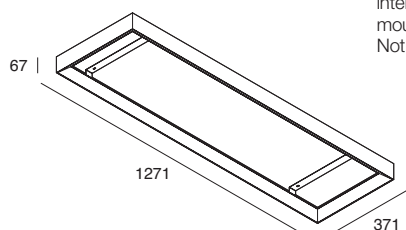
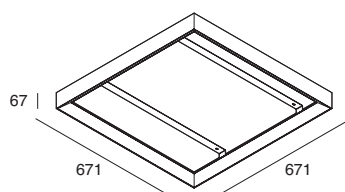

## THE PANEL 2

### ACCESSORI PER INSTALLAZIONE A SOSPENSIONE ACCESSORIES FOR SUSPENSION MOUNTED

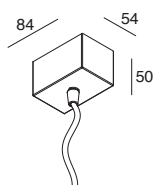

KIT DI ALIMENTAZIONE

POWER SUPPLY KIT

CODE  L (mm) Cavo / Cable (mm<sup>2</sup>)

<b>108919.01</b>	1200	3x1,5
<b>108920.01</b>	3000	3x1,5
<b>108921.01</b>	1200	5x1,5
<b>108922.01</b>	3000	5x1,5

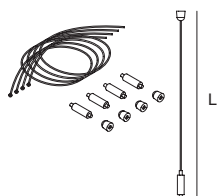

KIT n.4 SOSPENSIONI  
per versioni 600x600 e 1200x300.

KIT nos.4 SUSPENSIONS  
for 600x600 and 1200x300 versions.

CODE L (mm)

**16223.99** 3000

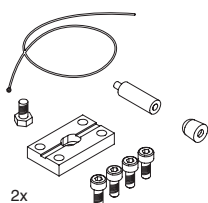

KIT n.2 GIUNTI + SOSPENSIONI  
per versioni 600x600 e 1200x300.

KIT nos.2 JOINTS + SUSPENSIONS  
for 600x600 and 1200x300 versions.

CODE  L (mm)

**16227.96** 3000

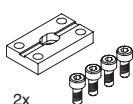

KIT n.2 GIUNTI (privi di sospensioni)  
per versioni 600x600 e 1200x300.

KIT nos.2 JOINTS (without suspensions)  
for 600x600 and 1200x300 versions.

CODE

**16232.96**

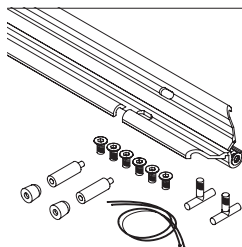

KIT SNODO + n.2 SOSPENSIONI  
per versione 600x600  
profilo in lega di alluminio verniciato.

KIT HINGE + nos.2 SUSPENSIONS  
for 600x600 version  
profile in powder coated aluminium alloy.

CODE  L (mm)

**16228.01** 3000

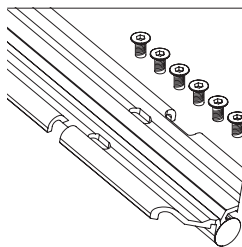

KIT SNODO (privo di sospensioni)  
per versione 1200x300  
profilo in lega di alluminio verniciato.

KIT HINGE (without suspensions)  
for 1200x300 version  
profile in powder coated aluminium alloy.

CODE

**16234.01**

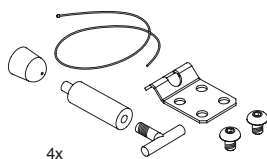

KIT n.4 SOSPENSIONI INCLINATE  
per versioni 600x600 e 1200x300

KIT nos.4 INCLINED SUSPENSIONS  
for 600x600 and 1200x300 versions

CODE L (mm)

**16230.99** 3000

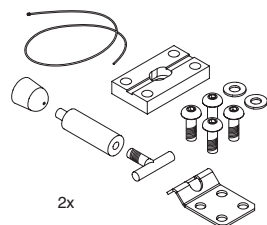

KIT n.2 GIUNTI + SOSPENSIONI +  
STAFFE INCLINATE  
per versione 600x600.

KIT nos.2 JOINTS + SUSPENSIONS +  
INCLINED BRACKETS  
for 600x600 version.

CODE  L (mm)

**16231.96** 3000

## THE PANEL 2

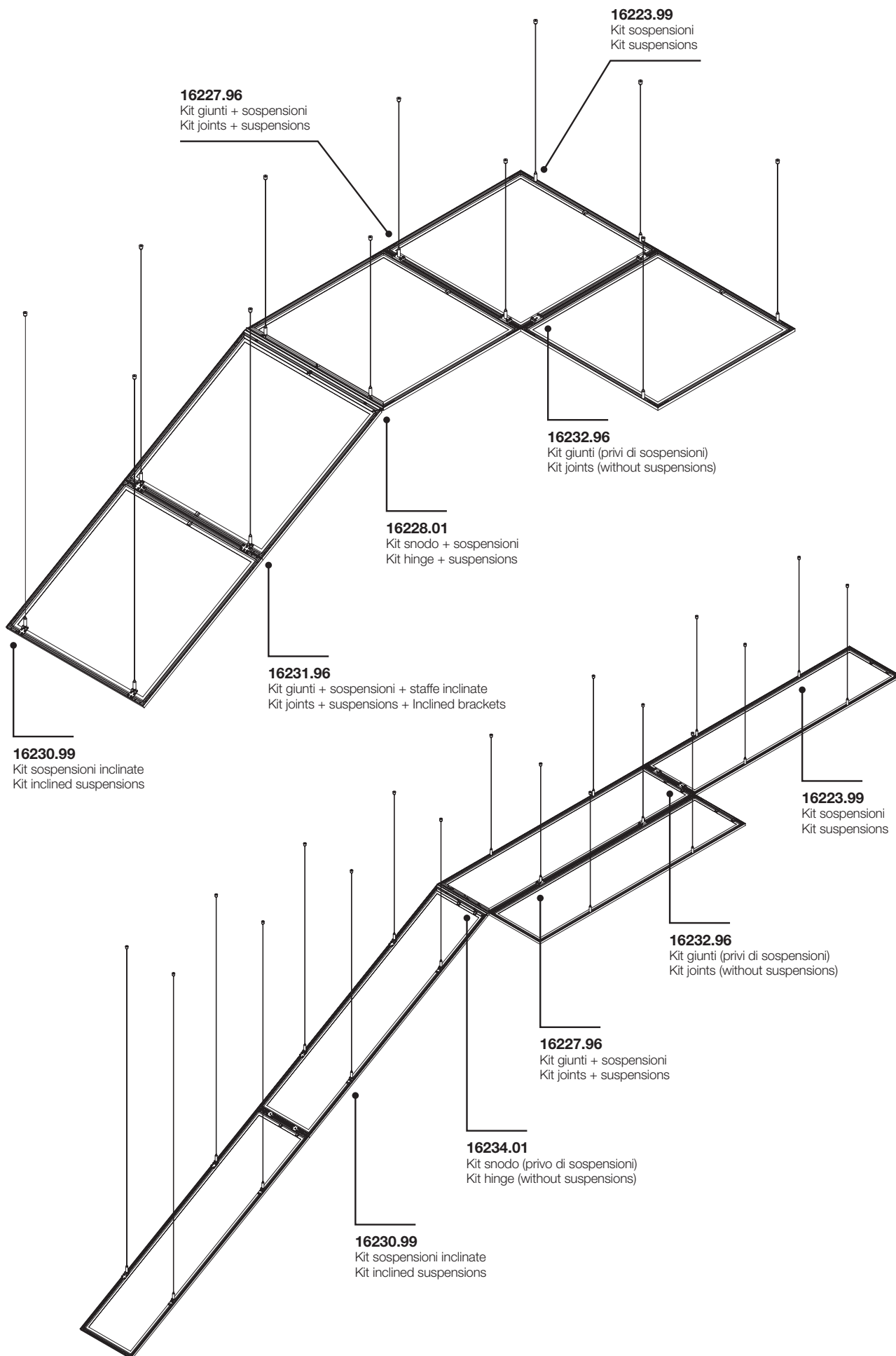
COMPOSIZIONI SOPPESE  
SUSPENDED COMPOSITIONS

## THE PANEL 2

### ACCESSORI PER INSTALLAZIONE A BINARIO ACCESSORIES FOR TRACK MOUNTED

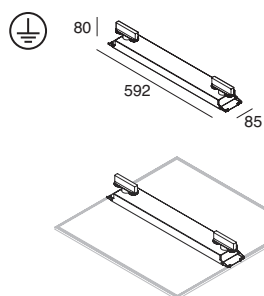

KIT BINARIO 600x600  
completo di 2 adattatori  
(elettrico/meccanico)  
per binario elettrificato All-Track.

KIT FOR TRACK MOUNTING 600x600  
supplied with 2 adaptors  
(electrical/mechanical)  
for electrified All-Track.

CODE  VERSION

<b>102055.01</b>	3P+DALI
<b>102053.01</b>	3P

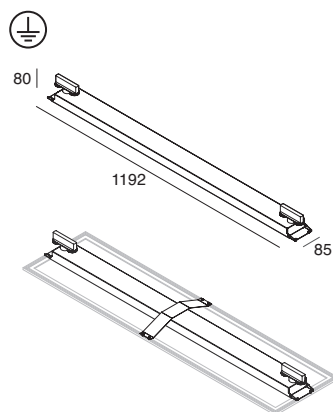

KIT BINARIO 1200x300  
completo di 2 adattatori  
(elettrico/meccanico)  
per binario elettrificato All-Track.

KIT FOR TRACK MOUNTING 1200x300  
supplied with 2 adaptors  
(electrical/mechanical)  
for electrified All-Track.

CODE  VERSION

<b>102056.01</b>	3P+DALI
<b>102054.01</b>	3P

## THE PANEL 2

### ACCESSORI EMERGENZA ACCESSORIES EMERGENCY

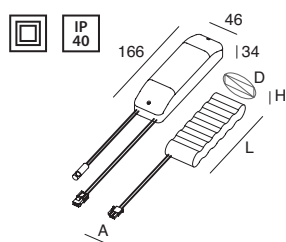

KIT DI ALIMENTAZIONE IN EMERGENZA  
Per versioni 600x600 e 1200x300, per  
installazione ad incasso o a plafone con Box  
(102033.01, 102034.01).  
Completo di connettori polarizzati per il  
collegamento dell'alimentatore.

KIT FOR EMERGENCY  
For 600x600 and 1200x300 versions,  
for recessed installation or ceiling installation  
with Box (102033.01, 102034.01)  
Polarized connectors included.

CODE	TIME	CHARGE	A (mm)	D (mm)	H (mm)	L (mm)
<b>102025.99</b>	1h	24h	46	59	23	138
<b>102026.99</b>	1,5h	12h	80	92	45	212
	3h	24h				

Flusso in emergenza  
Emergency flux

<b>THE PANEL 2</b>	<b>35W</b>	<b>17%</b>
<b>THE PANEL 2 MICROPRISMATICO</b>	<b>35W</b>	<b>17%</b>

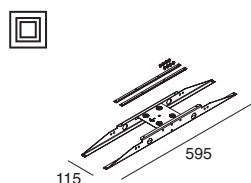

KIT PER FISSAGGIO A PLAFONE /  
SOSPENSIONE + KIT EMERGENZA  
Per versioni 600x600 e 1200x300,  
non installabile a parete o in fila continua.  
Kit con emergenza 1h integrata.  
Distanza tra prodotto e soffitto 40 mm.

KIT FOR CEILING MOUNTING / SUSPENDING  
+ EMERGENCY 1H  
For 600x600 and 1200x300 versions,  
not suitable for wall surface or continuous line  
installation. 1h emergency kit integrated.  
Distance between the fixture and the ceiling  
40 mm.

CODE	TIME	CH
<b>16222.99</b>	1h	24h

Flusso in emergenza  
Emergency flux

<b>THE PANEL 2</b>	<b>35W</b>	<b>17%</b>
<b>THE PANEL 2 MICROPRISMATICO</b>	<b>35W</b>	<b>17%</b>