

*Made in Italy*

# L-35 EVO

10

L-35 EVO



Linee di luce LED di larghezza 35mm, per installazione ad incasso su cartongesso, a parete o soffitto, tagliabile in opera. Versione con basi cablate e versione con supporti per strip LED.

### Materiali

Corpo in cartongesso di spessore 12,5mm, da lastra standard o HYDRO (a ridotto assorbimento di acqua, utilizzabile in ambienti con umidità relativa costante dell'aria  $\leq 70\%$ ; da associare a Strip LED IP65. Non utilizzabile con basi cablate).

Basi cablate e supporti per strip LED in lamiera di acciaio zincata e verniciata.

Schermo di protezione in PC opale.

Profilo dissipante per strip LED in lega di alluminio anodizzata naturale.

### Cablaggi

Basi cablate LED 3000K o 4000K con alimentazione elettronica 220-240V 50/60Hz o dimmerabile DALI/PUSH integrate.

Basi per Strip LED con alimentazione elettronica 24Vdc o dimmerabile (da ordinare separatamente).

LED light lines 35mm wide, for recessed installation in plasterboard walls or ceilings. Cutable to measure on site.

Available in power units version and with kit for strip LED version.

### Materials

Body made from 12,5mm thick plasterboard either standard or HYDRO treated (with reduced water absorption level, to be used in environments with constant relative humidity levels of air  $\leq 70\%$ ; to combine with Strip LED IP65. Not to be used with power units).

LED power units and kit for strip LED in galvanized painted steel.

PC opal protection screen.

Dissipating profile for strip LED made of anodized aluminium alloy natural finish.

### Wiring

LED power units 3000K or 4000K, with integrated electronic driver 220-240V 50/60Hz or dimmable DALI/PUSH driver.

Kit for Strip LED with electronic or dimmable driver 24Vdc (to be ordered separately).





*Infinity*  
wellness club

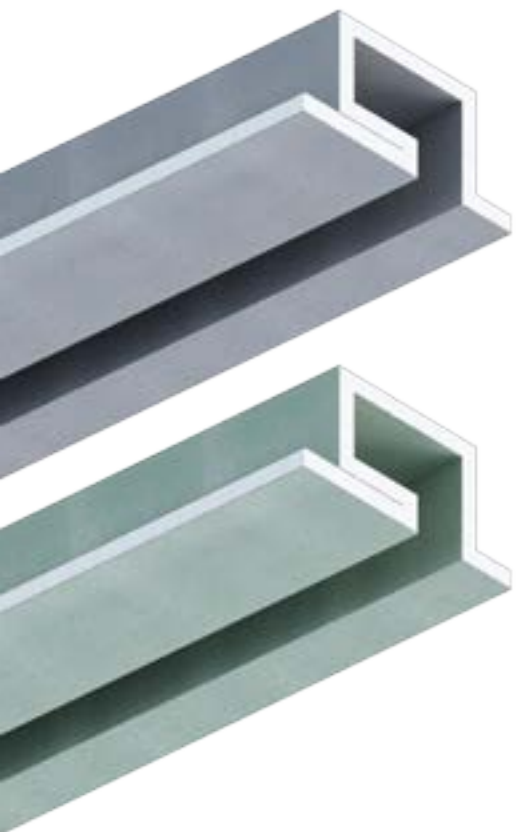

**L-35 EVO profilo in cartongesso**

spessore 12,5mm. Base cablata, supporti per strip LED e schermo diffusore da ordinare a parte

**L-35 EVO plasterboard profile**

12,5mm thickness. Power unit, kit for strip LED and diffuser to be ordered separately

Codice/Code	L (mm)	Prezzo/Price
<b>101815.99</b>	2000	<b>€ 127,25</b>

**L-35 EVO profilo in cartongesso HYDRO**

spessore 12,5mm. Supporti per strip LED, profilo dissipante, strip LED IP65 e schermo diffusore da ordinare a parte

**L-35 EVO HYDRO plasterboard profile**

12,5mm thickness. Kit for strip LED, dissipating profile, strip LED IP65 and diffuser to be ordered separately

Codice/Code	L (mm)	Prezzo/Price
<b>101816.99</b>	2000	<b>€ 137,00</b>

12  
L-35 EVO

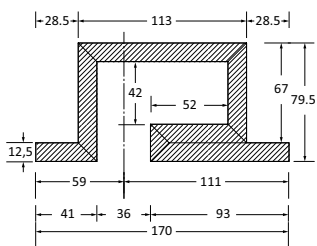
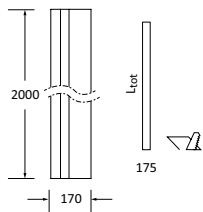

**SCHEMA DI MONTAGGIO / ASSEMBLY DRAWING**

- ①\_ TAGLIARE IL CARTONGESSO / CUT THE PLASTERBOARD
- ②\_ FISSARE IL CORPO IN CARTONGESSO ALLA STRUTTURA CON VITI / FIX THE FIXTURE BODY TO THE PLASTERBOARD STRUCTURE WITH SCREWS
- ③\_ STUCCARE E RASARE / PLAST, SKIM AND LEVEL THE SURFACE
- ④\_ VERNICIARE / PAINT

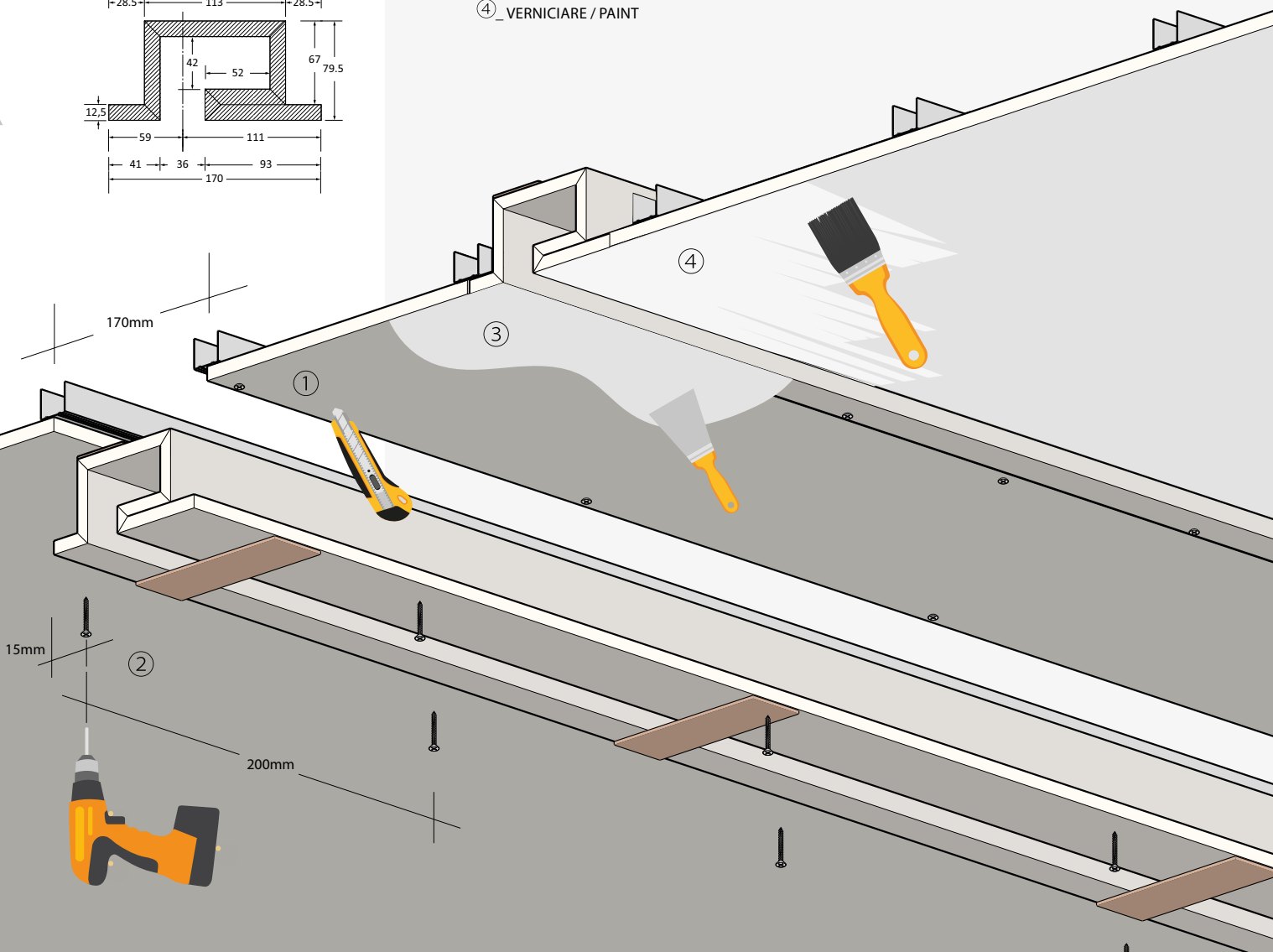



BASE CABLATA / POWER UNIT

- ⑤\_ INSERIRE L'ALIMENTATORE NEL FORO E POSIZIONARE NELL'APPOSITO SPAZIO LIBERO / INSERT THE DRIVER INTO THE CUT AND PUT IN THE SUITABLE PLACE
- ⑥\_ FISSARE IL SUPPORTO NEL TAGLIO / FIX THE BRACKET INTO THE CUT
- ⑦\_ INSERIRE LA BASE CABLATA (AGGANCIO MAGNETICO) / INSERT THE POWER UNIT (MAGNETIC CONNECTION)

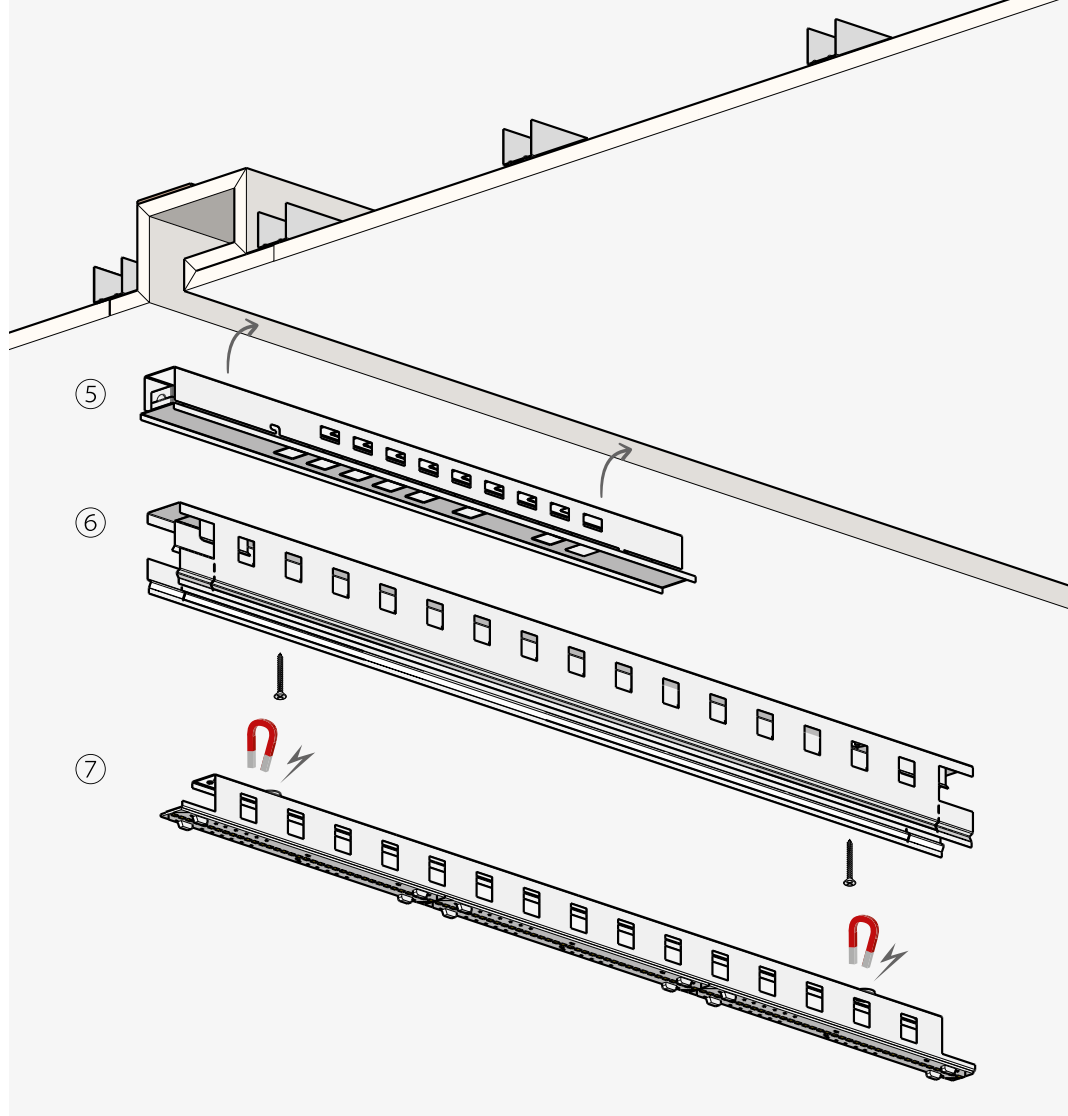

### L-35 EVO base cablata

in lamiera di acciaio zincata e verniciata in bianco. Alimentazione elettronica o dimmerabile DALI/PUSH, 220-240V 50/60Hz integrata, cablaggio passante per la continuità di linea. Profilo in cartongesso e schermo diffusore da ordinare a parte

### L-35 EVO power unit

made of galvanized steel white painted. Integrated electronic or dimmable DALI/PUSH driver 220-240V 50/60Hz, bypass cables for the continuity of line. Plasterboard profile and diffuser to be ordered separately

#### 3000K

Codice/Code	W led	L (mm)	Flusso apparecchio/Fixture flux (lm)	Prezzo/Price
<b>101818.99</b>	1x19	840	1143	<b>€ 130,75</b>
<b>101820.99</b>	1x25	1120	1524	<b>€ 149,25</b>
<b>101822.99</b>	1x32	1400	1905	<b>€ 162,75</b>

#### DIMMERABILE / DIMMABLE

Codice/Code	W led	Versione/Version	Prezzo/Price
<b>101824.99</b>	1x19	DALI/PUSH	<b>€ 185,00</b>
<b>101826.99</b>	1x25	DALI/PUSH	<b>€ 203,75</b>
<b>101828.99</b>	1x32	DALI/PUSH	<b>€ 217,00</b>

#### 4000K

Codice/Code	W led	L (mm)	Flusso apparecchio/Fixture flux (lm)	Prezzo/Price
<b>101817.99</b>	1x19	840	1197	<b>€ 130,75</b>
<b>101819.99</b>	1x25	1120	1596	<b>€ 149,25</b>
<b>101821.99</b>	1x32	1400	1995	<b>€ 162,75</b>

#### DIMMERABILE / DIMMABLE

Codice/Code	W led	Versione/Version	Prezzo/Price
<b>101823.99</b>	1x19	DALI/PUSH	<b>€ 185,00</b>
<b>101825.99</b>	1x25	DALI/PUSH	<b>€ 203,75</b>
<b>101827.99</b>	1x32	DALI/PUSH	<b>€ 217,00</b>

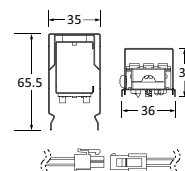
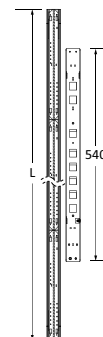
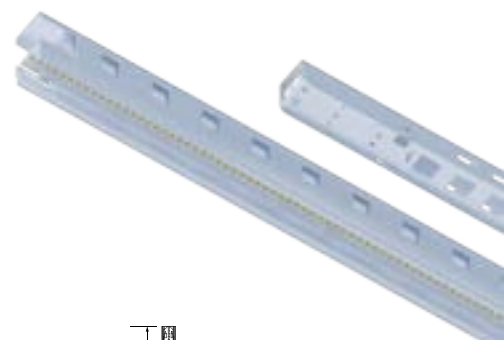

SOLO / ONLY  
ON/OFF

15

L-35 EVO

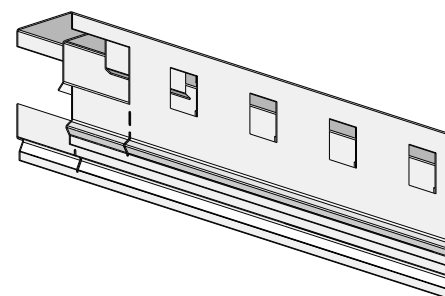

PRE-TRANCIATURA PER COMPOSIZIONI  
AD ANGOLO RETTO / PRE-SHEARED  
TO REALIZE 90 DEGREE CORNERS



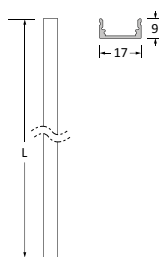
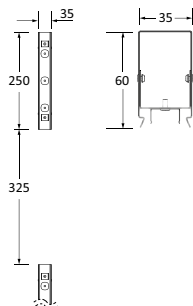
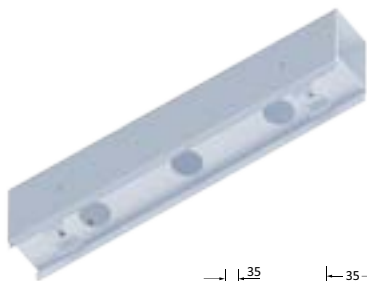

16

L-35 EVO

### L-35 EVO supporto per Strip LED

in lamiera di acciaio zincata e verniciata in bianco. Profilo dissipante, strip LED, alimentatore, schermo diffusore e profilo in cartongesso da ordinare a parte (prevedere un supporto ogni 500mm di profilo di cartongesso. Ad esempio 4 supporti per 2m di profilo)

### L-35 EVO kit for Strip LED

made of galvanized steel white painted. Plasterboard profile, strip LED, driver and diffuser to be ordered separately (install one kit each 500mm of plasterboard. Eg. 4 kit each 2m)

Codice/Code

Prezzo/Price

101829.99

€ 16,00

**STRIP LED CONSIGLIATE PER LUMINANZA UNIFORME - 22W/M E 19,2W/M (240 LED/M) - VEDI PAG. 56  
ALIMENTATORI E COMPONENTI PER LA GESTIONE LUCE - VEDI PAG. 61  
101301.99 E 101302.99 (ALTRI ALIMENTATORI E CONTROLLER DA PREVEDERE REMOTI)**

**/ RECOMMENDED STRIP LED FOR UNIFORM GLOW - 22W/M E 19,2W/M (240 LED/M) - SEE P. 56  
DRIVERS AND DEVICES FOR LIGHT MANAGEMENT - SEE P. 61  
101301.99 AND 101302.99 (OTHER DRIVERS AND CONTROLLERS REMOTE)**

### Profilo dissipante

in lega di alluminio anodizzata naturale. Da utilizzare per l'alloggiamento delle strip LED e da fissare su supporti da ordinare a parte, tagliabile in opera (vedere intervalli di sezionamento delle strip LED consigliate)

### Dissipating profile

made of anodized aluminium alloy, natural finish. To be used for kit for strip LED, to be ordered separately, cuttable on site (see the cutting intervals of the recommended strip LED)

Codice/Code

H (mm)

L (mm)

L1 (mm)

Prezzo/Price

101852.96

9

2000

17

€ 14,50

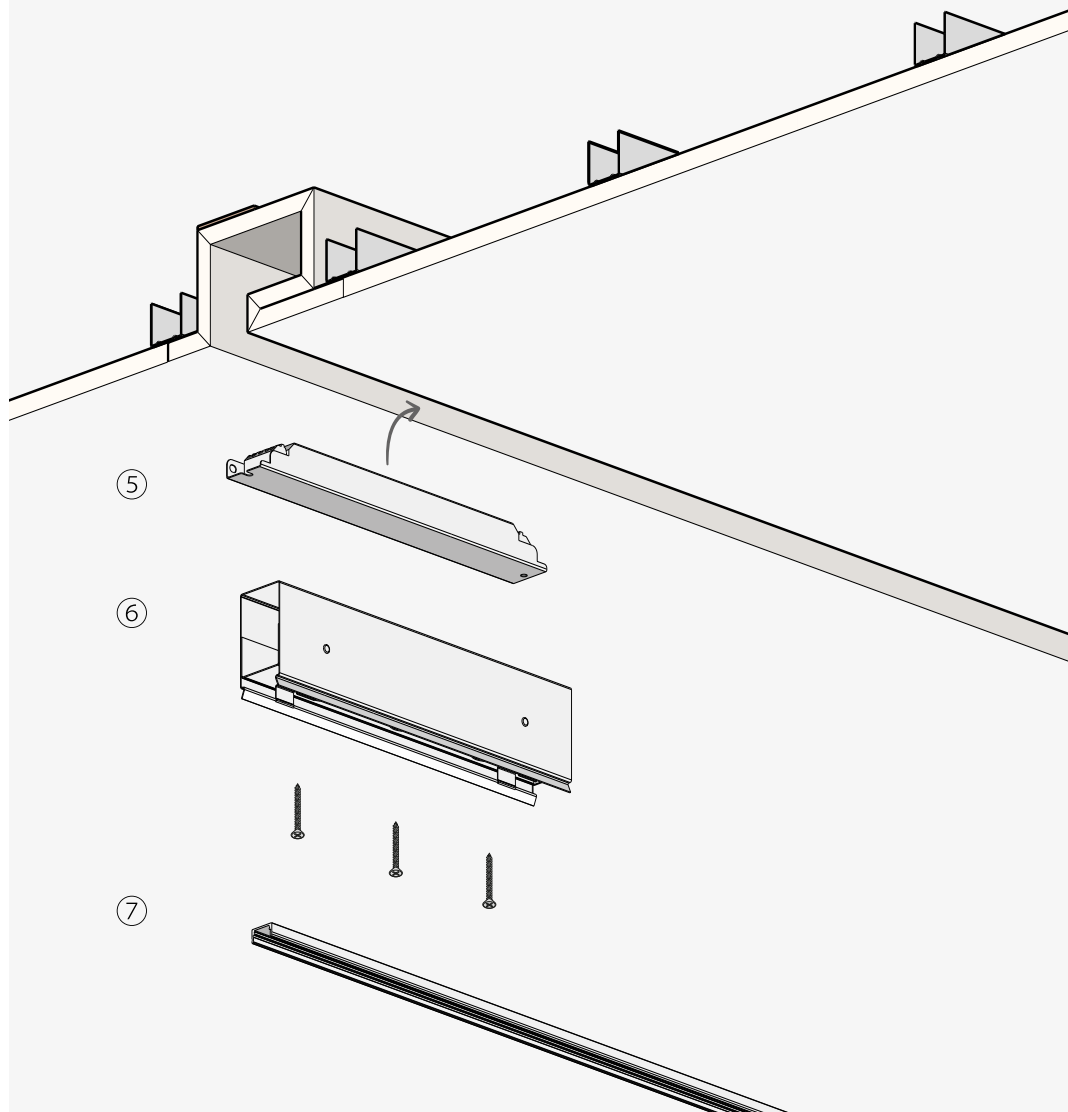

### SCHEMA DI MONTAGGIO / ASSEMBLY DRAWING

⑤\_ INSERIRE L'ALIMENTATORE NEL FORO E POSIZIONARE NELL'APPOSITO SPAZIO LIBERO (SOLO 101301.99 E 101302.99 ALTRI ALIMENTATORI E CONTROLLER DA PREVEDERE REMOTI)  
/ INSERT THE DRIVER INTO THE CUT AND PUT IN THE SUITABLE PLACE (ONLY 101301.99 AND 101302.99 OTHER DRIVERS AND CONTROLLERS REMOTE)

⑥\_ FISSARE IL SUPPORTO PER STRIPLED NEL TAGLIO / FIX THE KIT FOR STRIPLED INTO THE CUT

⑦\_ AGGANCIARE IL PROFILO DISSIPANTE (COMPLETATO CON STRIPLED) / INSERT THE DISSIPATING PROFILE (COMPLETED WITH STRIPLED)

L-35 EVO schermo diffusore policarbonato opale, tagliabile in opera su misura

L-35 EVO diffuser made of opal polycarbonate, cuttable on measure on site

Codice/Code	L (mm)	Prezzo/Price
10115.99	3000	€ 21,50
10116.99	2000	€ 15,00

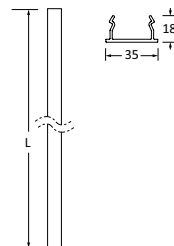
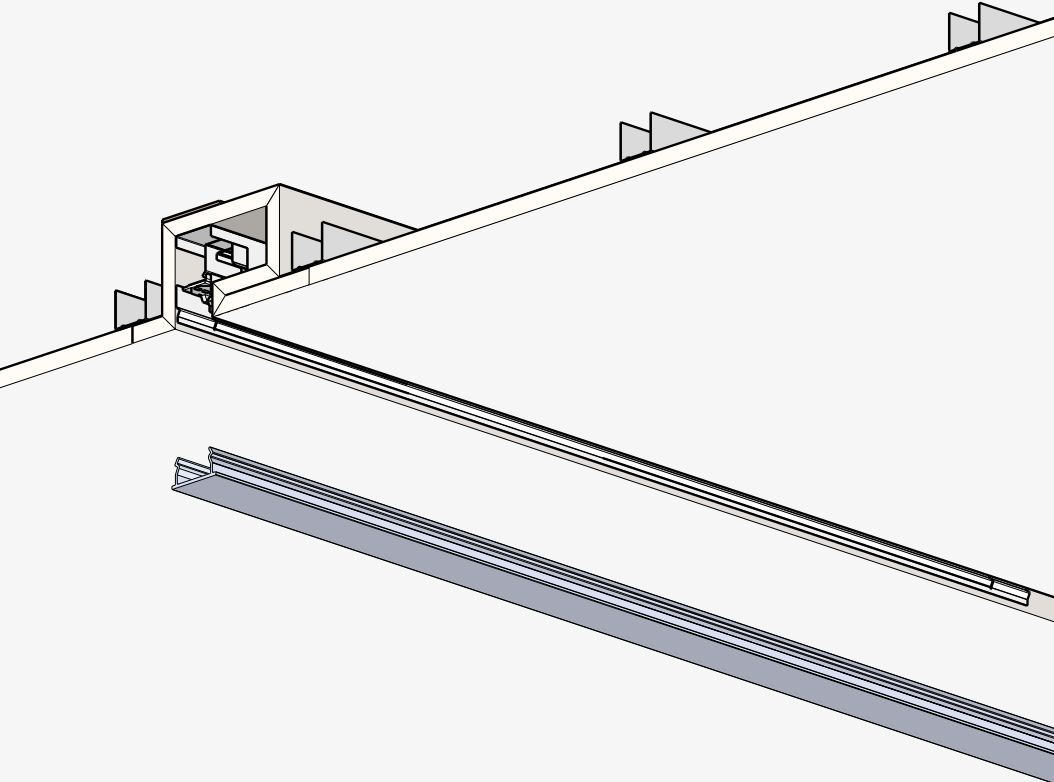

SCHEMA DI MONTAGGIO / ASSEMBLY DRAWING

\_ AGGANCIARE IL DIFFUSORE  
/ INSERT THE DIFFUSER

