

# L-09

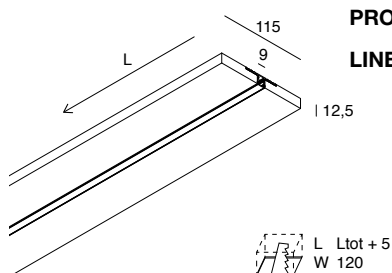

Profilo per Strip LED tagliabile in opera, per realizzare linee di luce incassate nel cartongesso.  
Corpo in cartongesso di spessore 12,5 mm da lastra standard o HYDRO (a ridotto assorbimento di acqua, utilizzabile in ambienti con umidità relativa costante dell'aria  $\leq 70\%$ ).  
Profilo dissipante in lega di alluminio anodizzato naturale e schermo di protezione in PMMA opale inclusi.  
Strip LED e alimentatore elettronico 24Vdc remoto da ordinare a parte.

Profile for Strip LED, for light cut on plasterboard.  
Body made of 12,5 mm thick plasterboard, either standard or HYDRO treated (with reduced water absorption level to be used in environments with constant relative humidity levels of air  $\leq 70\%$ ).  
Dissipating profile made of anodized aluminium alloy natural finish and PMMA opal diffuser included.  
Strip LED and remote electronic driver 24Vdc to be ordered separately.



## PROFILO LINEARE

### LINEAR PROFILE

CODE	L (mm)	Version
<b>101898.99</b>	2000	Standard
<b>101899.99</b>	2000	HYDRO

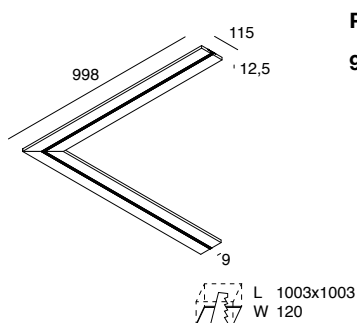

## PROFILO ANGOLARE 90°

### 90° CORNER PROFILE

CODE	L (mm)	Version
<b>1018A0.99</b>	998x998	Standard
<b>1018A1.99</b>	998x998	HYDRO

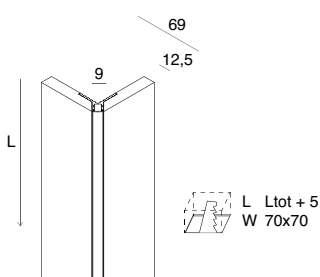

## L-09 CORNER

profilo lineare per spigolo esterno  
non installabile direttamente  
su muratura

## L-09 CORNER

linear profile for external corner  
not for direct installation  
on hard surfaces

CODE	L (mm)	Version
<b>1018A8.99</b>	2000	Standard
<b>1018A9.99</b>	2000	HYDRO

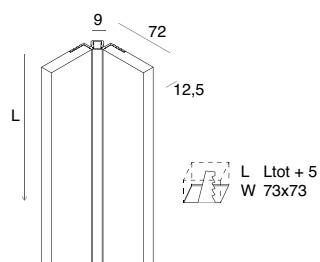

## L-09 EDGE

profilo lineare per spigolo interno

## L-09 EDGE

linear profile for internal corner

CODE	L (mm)	Version
<b>1018A6.99</b>	2000	Standard
<b>1018A7.99</b>	2000	HYDRO

# L-09 WALL

Profilo per Strip LED tagliabile in opera, per realizzare linee di luce incassate in muratura.

Profilo tagliabile in opera in lega di alluminio anodizzata naturale e rete di armatura porta-intonaco in acciaio zincato.

Schermo di protezione in PMMA opale incluso.

Strip LED e alimentatore elettronico remoto da ordinare a parte.

Profile for Strip LED for light cut on concrete or brick surface.

Length cuttable on measure on site.

Profile made of aluminium alloy and galvanized steel grid to plaster.

PMMA protection screen included.

Strip LED and remote electronic driver to be ordered separately.

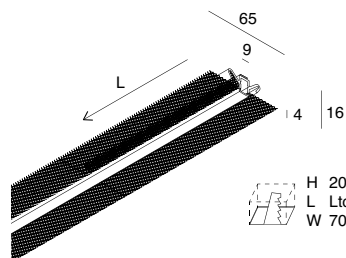

## PROFILO LINEARE

### LINEAR PROFILE

CODE L (mm)

**1018B0.99** 2000

## L-09 L-09 WALL

### ACCESSORI ACCESSORIES

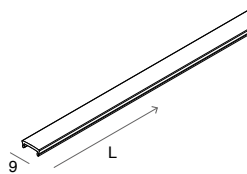

SCHERMO OPALE 6 m  
opzionale

OPAL SCREEN 6 m  
optional

CODE L (mm)

**1018A2.99** 6000 Opale / Opal

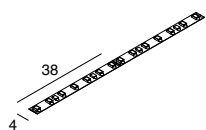

STRIP LED 4 mm  
11,5W/m

CODE L (mm) LED COLOUR FLUX/m IP CRI

**100913.99** 5000 2700K 1050 20 90

**100914.99** 5000 3000K 1113 20 90

**100915.99** 5000 4000K 1163 20 90

SMD 2216 (182 LED/m)  
Biadesivo - sezionabile ogni 38 mm (7 LED)  
Biadeshesive - cuttable every 38 mm (7 LED)