

# EASY LED

25W - 2523 lm • 32W - 3155 lm

Valori per monolampada darklight

Single lamp dark light values

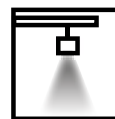
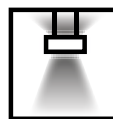
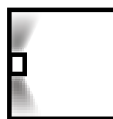

Made in Italy



\_.01 - BIANCO/WHITE



\_.03 - GRIGIO/GRAY



40

Sistema LED (singolo o a fila continua) per installazione a plafone, parete, sospensione o binario elettrificato Eurostandard trifase.

Disponibili versioni con ottica dark light speculare a bassa luminanza, oppure con schermo opale.

Emissione diretta, indiretta o diretta/indiretta (a seconda delle versioni). Sorgenti LED warm white 3000K o neutral white 4000K.

#### Materiali

Corpo in lamiera di acciaio zincata e priverivestita con film PVC; testate terminali, giunti, carter e staffe di fissaggio a parete in policarbonato; ottica dark light in policarbonato autoestinguente V2 metallizzato in alto vuoto oppure schermo in policarbonato opale autoestinguente V2.

#### Cablaggio

Alimentazione elettronica 220-240V 50-60Hz integrata, disponibile anche con elettrificazione dimmerabile DALI/PUSH e versione con gruppo di alimentazione in emergenza a servizio continuo 1 ora.

LED system (in stand-alone or in continuous lines) for ceiling or wall surface installation, or suspended, or for track mounting on electrified Eurostandard three-phase Novatrack. Available in versions with dark light mirrored low luminance louver, or with opal diffuser. Emission: direct; indirect; direct/indirect (depending on the version). LED warm white 3000K or neutral white 4000K sources.

#### Materials

Body made of zinc coated sheet steel prefinished with PVC film; end caps, junctions, carters and wall brackets made of polycarbonate; dark light louver made of self-extinguishing V2 polycarbonate with metallic finish by vacuum process, or diffuser made of self-extinguishing V2 opal polycarbonate.

#### Wiring

Integrated electronic driver 220-240V 50/60Hz, available also with dimmable DALI/PUSH driver and version with 1 hour continued-service emergency pack.

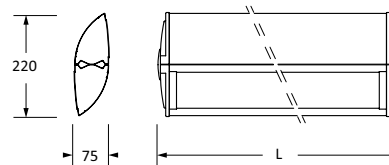
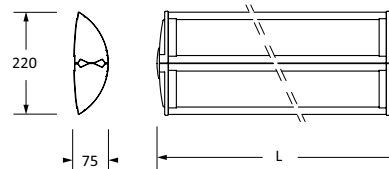
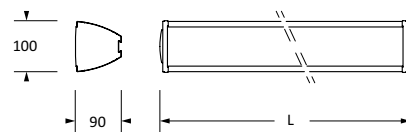

**EASY LED MONOLAMPADA DARK LIGHT** per installazione a plafone (senza l'utilizzo di accessori), sospensione o binario; alimentatore elettronico, schermi dark light e kit di giunzione inclusi; accessori per l'installazione da ordinare a parte

**EASY LED SINGLE LAMP DARK LIGHT** ceiling (without accessories), suspended or track mounted; electronic driver, dark light louver and kit for junction included; kit for installation to be ordered separately

### 3000K

Codice/Code	W led	L (mm)	Flusso apparecchio (lm) / Fixture flux (lm)
<b>13533.</b> __	25	1207	2504
<b>13535.</b> __	32	1494	3129

#### DIMMERABILE / DIMMABLE

Potenza/Power	1...10V	DALI
<b>25</b>	-	<b>13541.</b> __
<b>32</b>	-	<b>13543.</b> __

#### EMERGENZE / EMERGENCY

emerg.	em. + 1...10V	em. + DALI
<b>13537.</b> __	-	<b>13545.</b> __
<b>13539.</b> __	-	<b>13547.</b> __

### 4000K

Codice/Code	W led	L (mm)	Flusso apparecchio (lm) / Fixture flux (lm)
<b>13534.</b> __	25	1207	2523
<b>13536.</b> __	32	1494	3155

#### DIMMERABILE / DIMMABLE

Potenza/Power	1...10V	DALI
<b>25</b>	-	<b>13542.</b> __
<b>32</b>	-	<b>13544.</b> __

#### EMERGENZE / EMERGENCY

emerg.	em. + 1...10V	em. + DALI
<b>13538.</b> __	-	<b>13546.</b> __
<b>13540.</b> __	-	<b>13548.</b> __



**EASY LED MONOLAMPADA OPALE** per installazione a plafone (senza l'utilizzo di accessori), sospensione o binario; alimentatore elettronico, schermo opale e kit di giunzione inclusi; accessori per l'installazione da ordinare a parte

**EASY LED SINGLE LAMP OPAL** ceiling (without accessories), suspended or track mounted; electronic driver, opal diffuser and kit for junction included; kit for installation to be ordered separately

### 3000K

Codice/Code	W led	L (mm)	Flusso apparecchio (lm) / Fixture flux (lm)
<b>13501.</b> __	25	1207	2285
<b>13503.</b> __	32	1494	2857

#### DIMMERABILE / DIMMABLE

Potenza/Power	1...10V	DALI
<b>25</b>	-	<b>13509.</b> __
<b>32</b>	-	<b>13511.</b> __

#### EMERGENZE / EMERGENCY

emerg.	em. + 1...10V	em. + DALI
<b>13505.</b> __	-	<b>13513.</b> __
<b>13507.</b> __	-	<b>13515.</b> __

### 4000K

Codice/Code	W led	L (mm)	Flusso apparecchio (lm) / Fixture flux (lm)
<b>13502.</b> __	25	1207	2303
<b>13504.</b> __	32	1494	2880

#### DIMMERABILE / DIMMABLE

Potenza/Power	1...10V	DALI
<b>25</b>	-	<b>13510.</b> __
<b>32</b>	-	<b>13512.</b> __

#### EMERGENZE / EMERGENCY

emerg.	em. + 1...10V	em. + DALI
<b>13506.</b> __	-	<b>13514.</b> __
<b>13508.</b> __	-	<b>13516.</b> __

### SCHEMA DI MONTAGGIO, INSTALLAZIONE A PLAFONE. / ASSEMBLY DRAWING, CEILING INSTALLATION.



\_01 - Bianco/White

\_03 - Grigio/Grey

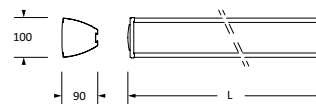

\_01 - Bianco/White

\_03 - Grigio/Grey

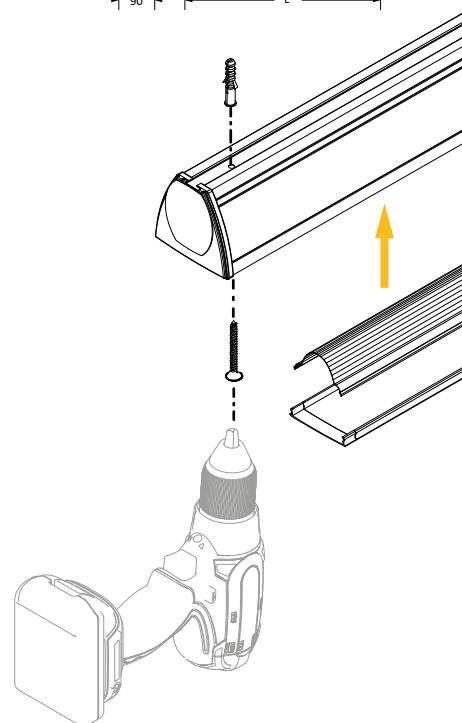
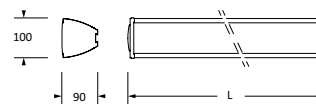



□ \_01 - Bianco/White

■ \_03 - Grigio/Grey

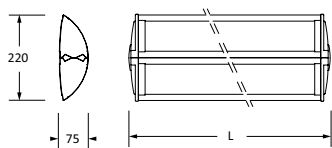

**EASY LED BILAMPADA MONOEMISSIONE DARK LIGHT** per installazione a plafone, parete, sospensione o binario; alimentatore elettronico, schermi dark light e kit di giunzione inclusi; accessori per l'installazione da ordinare a parte

**EASY LED DOUBLE LAMP SINGLE EMISSION DARK LIGHT** ceiling, wall, suspended or track mounted; electronic driver, dark light louver and kit for junction included; kit for installation to be ordered separately

### 3000K

Codice/Code	W led	L (mm)	Flusso apparecchio (lm) / Fixture flux (lm)
<b>13549.</b> __	2x25	1225	4910
<b>13551.</b> __	2x32	1512	6137

#### DIMMERABILE / DIMMABLE

Potenza/Power	1...10V	DALI	EMERGENZE / EMERGENCY		
<b>2x25</b>	-	<b>13557.</b> __	<b>13553.</b> __	-	<b>13561.</b> __
<b>2x32</b>	-	<b>13559.</b> __	<b>13555.</b> __	-	<b>13563.</b> __

### 4000K

Codice/Code	W led	L (mm)	Flusso apparecchio (lm) / Fixture flux (lm)
<b>13550.</b> __	2x25	1225	4949
<b>13552.</b> __	2x32	1512	6186

#### DIMMERABILE / DIMMABLE

Potenza/Power	1...10V	DALI	EMERGENZE / EMERGENCY		
<b>2x25</b>	-	<b>13558.</b> __	<b>13554.</b> __	-	<b>13562.</b> __
<b>2x32</b>	-	<b>13560.</b> __	<b>13556.</b> __	-	<b>13564.</b> __



□ \_01 - Bianco/White

■ \_03 - Grigio/Grey

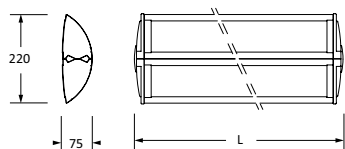

**EASY LED BILAMPADA MONOEMISSIONE OPALE** per installazione a plafone, parete, sospensione o binario; alimentatore elettronico, schermi opali e kit di giunzione inclusi; accessori per l'installazione da ordinare a parte

**EASY LED DOUBLE LAMP SINGLE EMISSION OPAL** ceiling, wall, suspended or track mounted; electronic driver, opal diffuser and kit for junction included; kit for installation to be ordered separately

### 3000K

Codice/Code	W led	L (mm)	Flusso apparecchio (lm) / Fixture flux (lm)
<b>13517.</b> __	2x25	1225	4571
<b>13519.</b> __	2x32	1512	5714

#### DIMMERABILE / DIMMABLE

Potenza/Power	1...10V	DALI	EMERGENZE / EMERGENCY		
<b>2x25</b>	-	<b>13525.</b> __	<b>13521.</b> __	-	<b>13529.</b> __
<b>2x32</b>	-	<b>13527.</b> __	<b>13523.</b> __	-	<b>13531.</b> __

### 4000K

Codice/Code	W led	L (mm)	Flusso apparecchio (lm) / Fixture flux (lm)
<b>13518.</b> __	2x25	1225	4607
<b>13520.</b> __	2x32	1512	5760

#### DIMMERABILE / DIMMABLE

Potenza/Power	1...10V	DALI	EMERGENZE / EMERGENCY		
<b>2x25</b>	-	<b>13526.</b> __	<b>13522.</b> __	-	<b>13530.</b> __
<b>2x32</b>	-	<b>13528.</b> __	<b>13524.</b> __	-	<b>13532.</b> __



**EASY LED BILAMPADA BIEMISSIONE DARK LIGHT** per installazione a parete, sospensione o binario.

Alimentatore elettronico, schermi dark light, diffusore opale per luce indiretta e kit di giunzione inclusi  
accessori per l'installazione da ordinare a parte

**EASY LED DOUBLE LAMP DOUBLE EMISSION DARK LIGHT** ceiling, wall, suspended or track mounted;  
electronic driver, dark light louver, opal diffuser for indirect lighting and kit for junction included; kit for installation  
to be ordered separately

**3000K**

Codice/Code	W led	L (mm)	Flusso apparecchio (lm) / Fixture flux (lm)
<b>13581.</b> __	2x25	1225	4757
<b>13583.</b> __	2x32	1512	5947

**DIMMERABILE / DIMMABLE**

Potenza/Power	1...10V	DALI
<b>2x25</b>	-	<b>13589.</b> __
<b>2x32</b>	-	<b>13591.</b> __

**EMERGENZE / EMERGENCY**

emerg.	em. + 1...10V	em. + DALI
<b>13585.</b> __	-	<b>13593.</b> __
<b>13587.</b> __	-	<b>13595.</b> __

**4000K**

Codice/Code	W led	L (mm)	Flusso apparecchio (lm) / Fixture flux (lm)
<b>13582.</b> __	2x25	1225	4795
<b>13584.</b> __	2x32	1512	5994

**DIMMERABILE / DIMMABLE**

Potenza/Power	1...10V	DALI
<b>2x25</b>	-	<b>13590.</b> __
<b>2x32</b>	-	<b>13592.</b> __

**EMERGENZE / EMERGENCY**

emerg.	em. + 1...10V	em. + DALI
<b>13586.</b> __	-	<b>13594.</b> __
<b>13588.</b> __	-	<b>13596.</b> __



□ \_\_01 - Bianco/White

■ \_\_03 - Grigio/Grey

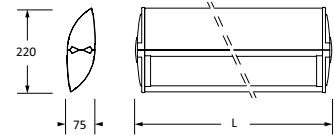

**EASY LED BILAMPADA BIEMISSIONE OPALE** per installazione a parete, sospensione o binario.

Alimentatore elettronico, schermi opali e kit di giunzione inclusi; accessori per l'installazione da ordinare a parte

**EASY LED DOUBLE LAMP DOUBLE EMISSION OPAL** ceiling, wall, suspended or track mounted; electronic driver,  
opal diffuser and kit for junction included; kit for installation to be ordered separately

**3000K**

Codice/Code	W led	L (mm)	Flusso apparecchio (lm) / Fixture flux (lm)
<b>13565.</b> __	2x25	1225	4560
<b>13567.</b> __	2x32	1512	5700

**DIMMERABILE / DIMMABLE**

Potenza/Power	1...10V	DALI
<b>2x25</b>	-	<b>13573.</b> __
<b>2x32</b>	-	<b>13575.</b> __

**EMERGENZE / EMERGENCY**

emerg.	em. + 1...10V	em. + DALI
<b>13569.</b> __	-	<b>13577.</b> __
<b>13571.</b> __	-	<b>13579.</b> __

**4000K**

Codice/Code	W led	L (mm)	Flusso apparecchio (lm) / Fixture flux (lm)
<b>13566.</b> __	2x25	1225	4596
<b>13568.</b> __	2x32	1512	5745

**DIMMERABILE / DIMMABLE**

Potenza/Power	1...10V	DALI
<b>2x25</b>	-	<b>13574.</b> __
<b>2x32</b>	-	<b>13576.</b> __

**EMERGENZE / EMERGENCY**

emerg.	em. + 1...10V	em. + DALI
<b>13570.</b> __	-	<b>13578.</b> __
<b>13572.</b> __	-	<b>13580.</b> __



□ \_\_01 - Bianco/White

■ \_\_03 - Grigio/Grey

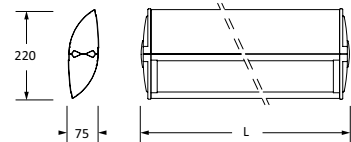

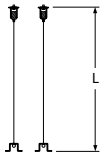

**KIT DI SOSPENSIONE REGOLABILE (2 PZ.)** cavi in acciaio con terminale in ottone cromato  
**ADJUSTABLE SUSPENSION KIT (2 PCS)** steel cables with tailpipes made of chromed brass

Codice/Code	L (mm)
<b>A1040</b>	1200
<b>A1040/M3</b>	3000

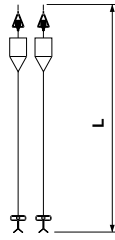

**KIT DI SOSPENSIONE REGOLABILE (2 PZ.)**  
 cavi in acciaio con staffe per il fissaggio in acciaio nichelato e rosone in ABS bianco  
**ADJUSTABLE SUSPENSION KIT (2 PCS)**  
 steel cables with brackets made of nickel-plated steel and canopy made of white ABS

Codice/Code	L (mm)
<b>A1000</b>	1200
<b>A1000/M3</b>	3000

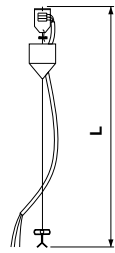

**KIT DI SOSPENSIONE/ALIMENTAZIONE REGOLABILE (1 PZ.)** cavi in acciaio con staffe per il fissaggio in acciaio nichelato, cavo di alimentazione con guaina bianca, rosone in ABS bianco  
**ADJUSTABLE SUSPENSION/POWER SUPPLY KIT (1 PC)** steel cables with brackets made of nickel-plated steel, power supply cable finished in white colour, canopy made of white ABS

Codice/Code	L (mm)	cavo alim. / power supply cable
<b>A1001</b>	1200	3x1,5
<b>A1001/M3</b>	3000	3x1,5

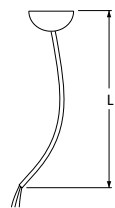

**KIT DI ALIMENTAZIONE PER SOSPENSIONE**  
 rosone in polipropilene, cavo di alimentazione con guaina trasparente  
**POWER SUPPLY KIT FOR SUSPENSION** canopy made of polypropylene, transparent power supply cable

Codice/Code	L (mm)	cavo alim. / power supply cable	colore cavo / cable colour
<b>A1041</b>	1200	3x1,5	trasparente / transparent
<b>A1041 3A</b>	1200	5x1,5	trasparente / transparent
<b>A1041/M3</b>	3000	3x1,5	trasparente / transparent
<b>A1041/M3 3A</b>	3000	5x1,5	trasparente / transparent

Disponibile a richiesta anche con rosone grigio (es. A1041 GR)  
 Available on demand with grey canopy (ex. A1041 GR)

- Bianco/White
- Grigio/Grey  
solo su richiesta / only on request

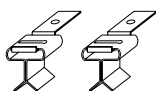

**STAFFA PER FISSAGGIO A PLAFONE (2 PZ.)** per Easy LED bilampada  
**CEILING BRACKET (2 PCS)** for Easy LED double lamp

Codice/Code
<b>A1002</b>

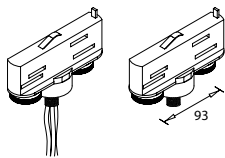

**ADATTATORI PER BINARIO ELETRIFICATO EUROSTANDARD TRIFASE (2 PZ.)**  
**ADAPTORS FOR ELECTRIFIED THREE-PHASE EUROSTANDARD TRACK (2 PCS)**

**EASY LED MONOLAMPADA**  
**EASY LED SINGLE LAMP**

Codice/Code	adattatori cablati / wired adaptors
<b>A036 GR-BI</b>	1

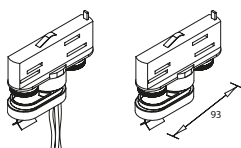

**EASY LED BILAMPADA**  
**EASY LED DOUBLE LAMP**

Codice/Code	adattatori cablati / wired adaptors
<b>A037BI-GR</b>	1

- \_BI - Bianco/White
- \_GR - Grigio/Grey