

B-1 / B-2 / B-3 / B4

Profilo per Strip LED tagliabile in opera per installazione a parete.
 Corpo e testate terminali in cartongesso, profilo dissipante in lega di alluminio anodizzata naturale.
 Staffe per installazione a parete in lamiera di acciaio zincata e verniciata, schermo di protezione in PMMA opale.
 Strip LED, testate terminali ed alimentatore elettronico 24Vdc da ordinare a parte.

Profile for Strip LED for wall surface mounting.
 Body and end caps made of plasterboard, dissipating profile in anodized aluminium alloy natural finish.
 Brackets in galvanized painted steel, PMMA opal screen.
 Strip LED, end caps and electronic driver 24 Vdc to be ordered separately.

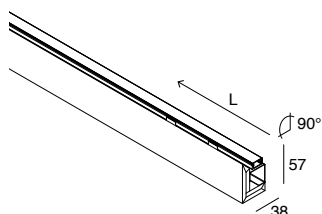

B-1
 Tagliabile in max 3 profili di lunghezza minima 250 mm
 Includi 3 staffe per il montaggio.
 Alimentatore remoto.

Cutttable in max 3 profiles up to a minimum length of 250 mm
 3 brackets included.
 Remote driver.

CODE	L (mm)
11119.99	2000

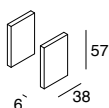

TESTATE DI CHIUSURA (2 pz.)
 END CAPS (2 pcs)

CODE	
11122.99	

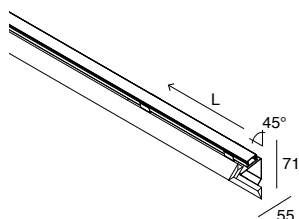

B-2
 Tagliabile in max 3 profili di lunghezza minima 250 mm
 Includi 3 staffe per il montaggio.
 Alimentatore remoto.

Cutttable in max 3 profiles up to a minimum length of 250 mm
 3 brackets included.
 Remote driver.

CODE	L (mm)
11120.99	2000

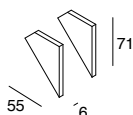

TESTATE DI CHIUSURA (2 pz.)
 END CAPS (2 pcs)

CODE	
11123.99	

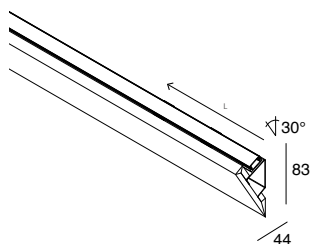

B-3
 Tagliabile in max 3 profili di lunghezza minima 250 mm
 Includi 3 staffe per il montaggio.
 Alimentatore remoto.

Cutttable in max 3 profiles up to a minimum length of 250 mm
 3 brackets included.
 Remote driver.

CODE	L (mm)
11121.99	2000

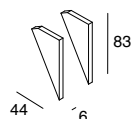

TESTATE DI CHIUSURA (2 pz.)
 END CAPS (2 pcs)

CODE	
11124.99	

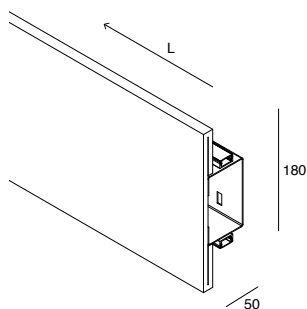
**B-4**

Tagliabile in max 4 profili di lunghezza minima 300 mm
Incluse 4 staffe per il montaggio
Alimentatore alloggiabile nel profilo (vedi accessori).

Cuttable in max 4 profiles up to a minimum length of 300 mm
4 brackets included
Driver suitable inside the profile (see accessories).

CODE L (mm)

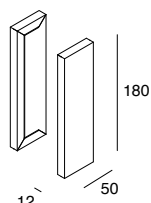
101869.99 2000

TESTATE DI CHIUSURA (2 pz.)
END CAPS (2 pcs)

CODE

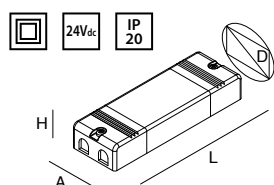
101870.99**B-1 / B-2 / B-3 / B4****ACCESSORI
ACCESSORIES**

ALIMENTATORE STABILIZZATO 24Vdc
220-240V 50/60Hz
Alloggiabile all'interno del profilo B4.

ELECTRONIC STABILIZED
DRIVER 24Vdc
220-240V 50/60Hz
Suitable inside the profile B4.

CODE POWER A (mm) D (mm) H (mm) L (mm)

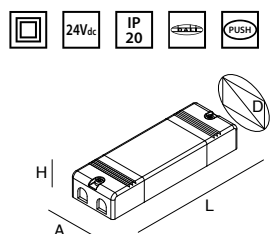
101301.99 45W 30 34 16 251**101302.99** 100W 30 35 18 320

ALIMENTATORE ELETTRONICO
DIMMERABILE 4 CANALI STABILIZZATO
24Vdc
220-240V 50/60Hz
Gestione DALI/PUSH per Strip LED bianche
e solo DALI per Strip LED RGB/RGBW
Alloggiabile all'interno del profilo B4.

ELECTRONIC DIMMABLE 4 CHANNELS
STABILIZED DRIVER 24Vdc
220-240V 50/60Hz
DALI/PUSH for white Strip LED and only
DALI for RGB/RGBW Strip LED
Suitable inside the profile B4.

CODE POWER A (mm) D (mm) H (mm) L (mm)

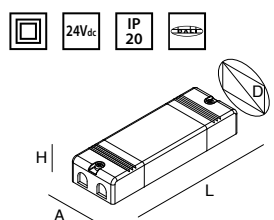
101305.99 80W 32 40 22 345

ALIMENTATORE ELETTRONICO
STABILIZZATO DIMMERABILE DALI DT8
24VDC 220-240V 50/60HZ
Gestione DALI per Strip LED tunable White.
Alloggiabile all'interno del profilo B4.

ELECTRONIC STABILIZED DIMMABLE DALI
DT8 DRIVER 24VDC 220-240V 50/60HZ
DALI for Tunable White Strip LED.
Suitable inside the profile B4.

CODE POWER A (mm) D (mm) H (mm) L (mm)

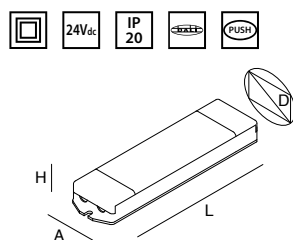
101306.99 80W 32 40 22 345

INTERFACCIA DI DIMMERAZIONE 24V
PER STRIP LED
Massimo carico 12Ax1 canale,
da associare ad un alimentatore 24Vdc
Alloggiabile all'interno del profilo B-4

INTERFACE FOR DIMMING 24V
FOR STRIP LED
Maximum load 12Ax1CH,
to be associated with one driver 24Vdc
Suitable inside the profile B-4

CODE A (mm) D (mm) H (mm) L (mm)

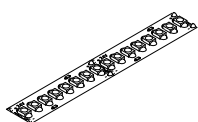
18001.99 51 58 26 155**STRIP LED**

Pag. 138